

# CS-600 G2

Front view

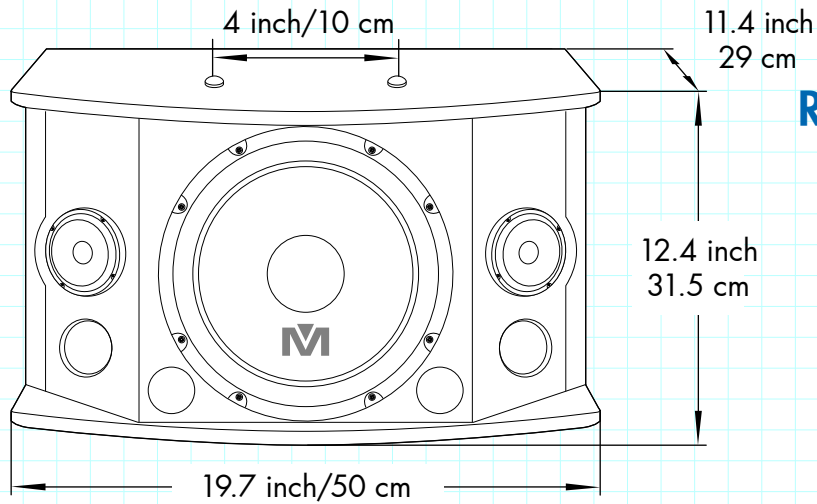

Rear view

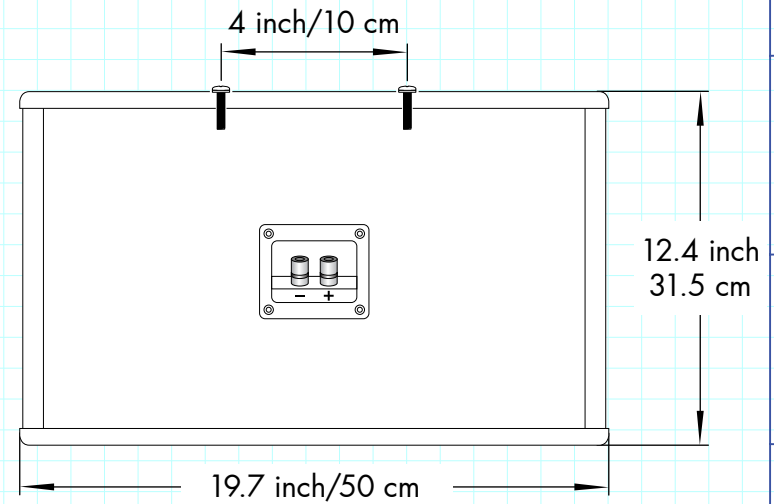

See-Through Top view

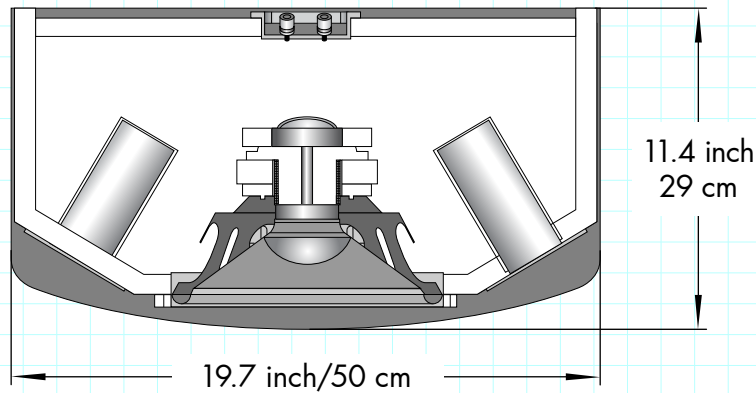

Side view

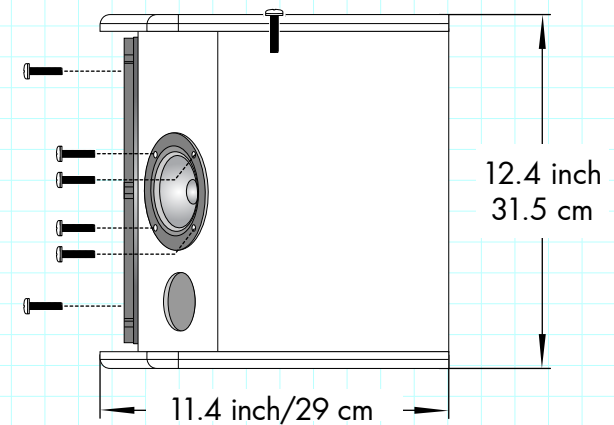

APPROVALS	DATE
DRAWN: LL	09/01/14
CHECK: VZ	09/01/14
DES ENG: SL	09/01/14

MODEL NO.  
**CS-600 G2**

SCALE 1:10

REW.NO	DATE
	09-01-2014